

Metal Cassette Ceiling with BEKA Heating and Cooling Mats

1. Generals

Modern office and business facilities must be cooled mostly throughout the whole year because of the internal loads generated by office and computer equipment and because of the high thermal insulation of walls and facades. During the heating period itself the rooms need comparatively little heating. Because of this the utilisation of the energetically low cost BEKA heating and cooling ceiling is possible. The BEKA heating and cooling mats are simply laid on top of the panels of the suspended metal cassette ceiling. This way each metal cassette ceiling can be utilised very easily and economically as a heating and cooling ceiling. This setup can also be used for renovation. Because of the combined function of the ceiling the investment cost for the building installations can be minimised.

2. System description

The BEKA heating and cooling mats are simply laid on top of the metal cassettes. The capillary tubes are positioned directly on the sheet metal or thin acoustic fibre. The surface is rapidly cooled-down or heated-up. The reaction time of the ceiling is less than 15 minutes.

3. Cold water/ heating water technology

The BEKA heating and cooling mats are tied-up in zones to the piping as a circuit and connected to the heating or cooling source. The connection to a storey distributor is recommended. For the cold-water preparation different techniques and systems can be utilised. The economical advantages of the cooling ceiling is basing on the fact that the ceiling will provide already high performances with supply temperatures, which are only slightly below the room temperature. This makes the utilisation of "alternative energy sources" such as heat pumps or open cooling and ground water possible. For the generating of heating water the same advantages are true. In connection with solar collector

systems and even with standard techniques significant energy savings are achieved, because already with low supply temperatures (below 40°C) it can be heated with respectable heating performances.

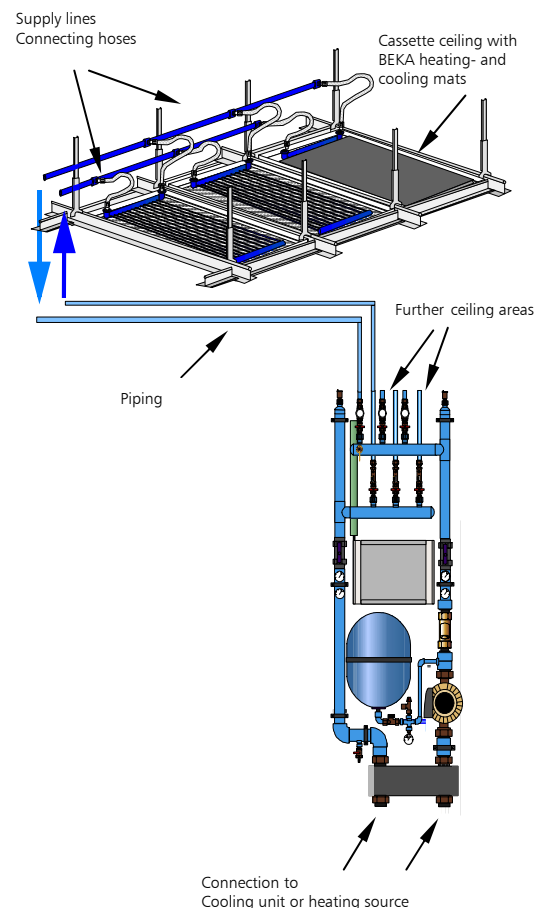

4. Installation

Generally the standard installation guidelines must be obeyed. All materials used in the BEKA heating and cooling mat system must be non-corrosive. Materials to be used can be: plastics, stainless steel, copper, brass and red brass. Other materials in use could cause sludge and could lead to malfunction of the system.

5. Regulating technology

The regulating technique provides for both the desired comfort and the necessary system reliability.

The cooling ceiling requires: Room temperature regulation, dew point protection and regulation of the supply temperature for the cold water. Supply temperatures below 16 °C must be avoided because of danger that the dew point could be reached!

For the heating ceilings, a room temperature control is required, which regulates the volume of heating water in dependence to the desired room temperature. In rooms higher than 3.5 m supply temperatures above 40°C must be avoided because of excessive surface temperatures!

6. Dimensioning of the installation

The BEKA heating and cooling mats are dimensioned according the dimensions of the metal cassettes. The necessary quantity of mats and temperature of the cooling water or heating water is determined according to the following layout tables. The supply temperature determined in the water circuit, taken at the side of the cooling unit or heat generator, is regulated with the water temperature upstream to the heat exchanger.

7. Preparation for installation

For the installation of the suspended metal cassette ceiling, the manufacturer's instructions must be followed.

The capillary tubes of the BEKA heating and cooling mats should have good contact to the surface of the metal cassettes so that the heat transfer is directly led to the water. If there are additional heat sources in the ceiling cavity (heat radiation from light fixtures, warm water pipes, etc.) a mineral wool mat can be laid on top of the capillary tubes for energy saving purpose. Sometimes such an installation could be required for the acoustic insulation of the ceiling. If this requirement is not set forth we recommend gluing the capillary tubes to the surfaces. The BEKA heating and cooling mats are produced in size of the metal cassettes based on

the project to avoid any tailoring work at the building site. At the border areas and areas where components are to be attached to the ceiling, inactive cassettes will be installed.

The BEKA heating and cooling mats are supplied with quick-action couplings for the connection of supply and return lines with flexible hoses.

Before starting work, a ceiling pattern and installation pattern must be drawn-up. All mats with their dimensions, direction of installation and the supply lines must be recorded.

In the ceiling pattern, all areas must be marked which will stay uncovered, i.e. for the installation of partition walls or light fixtures and other ceiling in-fills. Also the installation positions for the BEKA dew point sensor must be marked at the ceiling pattern.

The polypropylene piping is connected among each other by thermal welding.

Here the welding directions DVS 2207-11 of the Deutschen Verband für Schweisstechnik e.V. must be observed. (The ambient temperature must not drop below 5 °C. The pre-heating, welding and setting times for the individual pipe sizes are to be observed according to the relevant regulations.)

8. Tools, materials

For the installation of a metal cassette heating and cooling ceiling with BEKA capillary tube mats, standard tools and materials for ceiling constructions and installation of plastic pipes can be used, such as:

- Metal cassettes
- Suspension profiles and suspenders depending at the type of construction used for the particular ceiling.
- Dowels and screws
- Sheet metal scissors
- Mineral-wool insulating mats (if req.)
- Scissors to cut plastic piping
- Hand-held welder with sleeve welding adaptor for plastic welding
- Plastic fittings

For the connection of the supply lines to the cold water circuit a hand-held welder with sleeve welding adaptor and plastic fittings are recommended.

Alternatively compression fittings can be used.

9. Installation steps at the ceiling

- The supporting structure is fastened and aligned to the raw ceiling with nonius hangers according to manufacturer's recommendations of the chosen ceiling brand.
- The supply lines are laid into the ceiling cavity and connected to the main supply lines (connections done either by thermal welding or with compression fittings)
- The flexible connecting hoses are plugged into the quick-action couplings of the supply lines.

I.

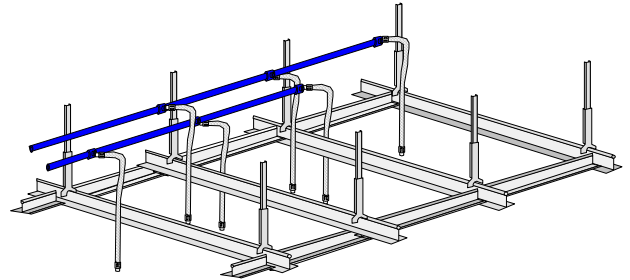

II.

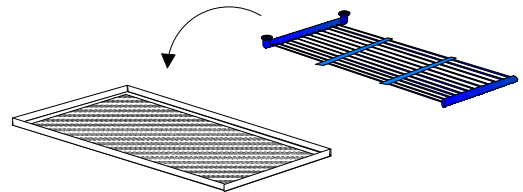

- The BEKA heating and cooling mats are laid into the cassettes and if necessary, fixed with BEKA adhesive V.K.1.

III.

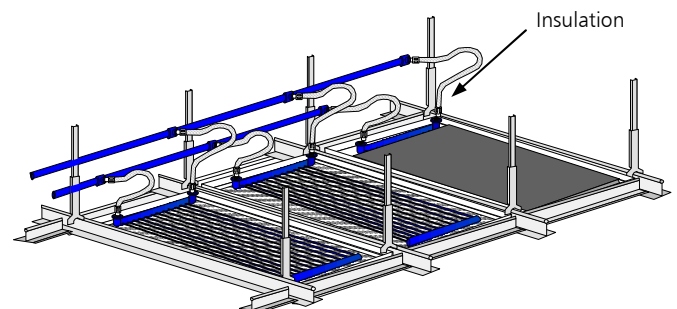

- Plug the flexible hoses into the quick-action couplings of the BEKA mats.
- The cassettes with the BEKA mats inserted are hung-up into the supporting structure and the joints aligned.
- If required, place insulating mats on top of it.
- Take pretest with compressed air at 10 bar for one hour.
- Take final test with water at 10 bar for 4 hours and maintain an pressure at rest of 3 bar until the system is taken into operation.

10. Layout for metal cassette cooling ceiling with BEKA capillary tube mats

Project:	Date :
Project consultant:	Lay-out valid for 27°C - room temperature and 2 K cooling water spread!

Required cooling capacity

1 Cooling load for the room	W		from calculation of the planning office
2 Planned coverage with mats	m ²		maximum possible arrangement derived from the room dimensions
3 Required specific cooling capacity	W/m ²		= cooling load / coverage

Determination of performance

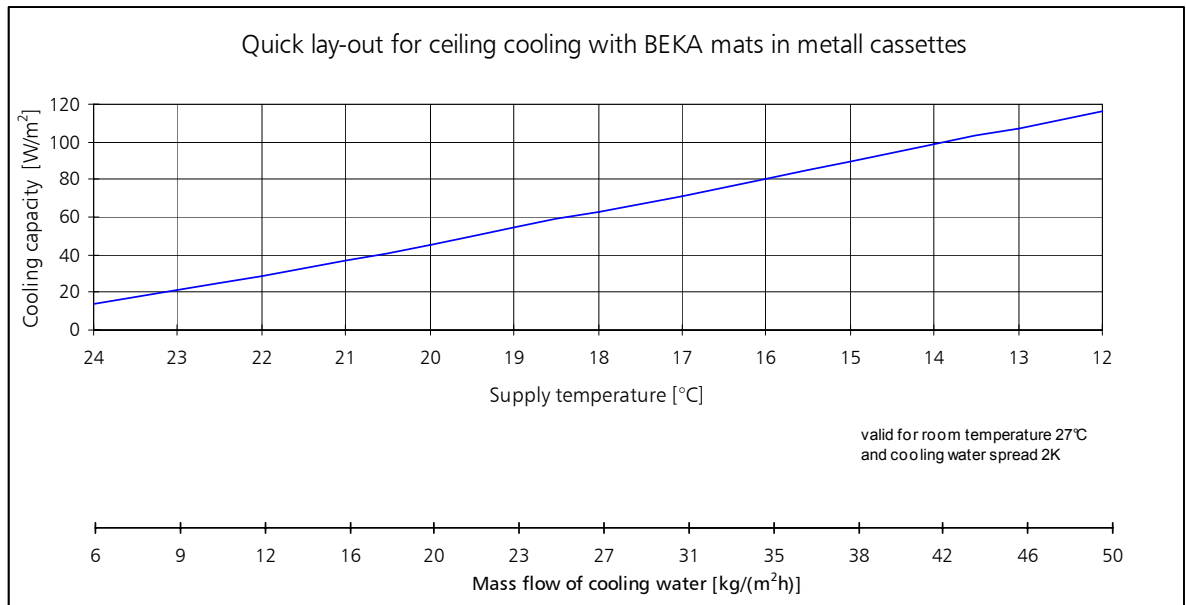

4 Supply temperature → from diagram 1	°C		
5 Return temperature	°C		
6 Water volume per mat	kg/m ² h		
7 Water volume per zone	l/h		

Pressure loss determination

8 Length of the connection pipe	m		
9 Resistance in the pipe → from diagram 2	Pa/m		
10 Pressure loss in pipe = pipe length * Resistance	Pa		
11 Pressure loss of the mat → with value of line 2 from diagram 1	Pa		
12 Addition for pressure loss through fittings (recomm: 30% addition to pipe)	Pa		
13 Addition for heat transfer station (recomm: for zone valves 500 - 1000 Pa for mains regulating valves 700 - 1500 Pa for heat exchanger approx. 4000 Pa)	Pa		
14 Total pressure loss	Pa		

*If BEKA heat transfer stations are utilised the determination of pressure loss can be omitted.
In this case only the quantity of cooling circuits and the total cooling capacity is required for the selection.*

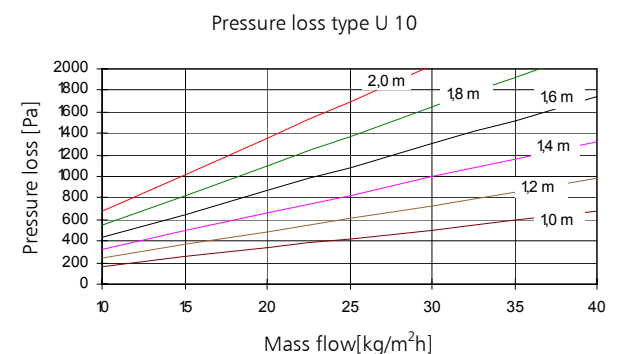
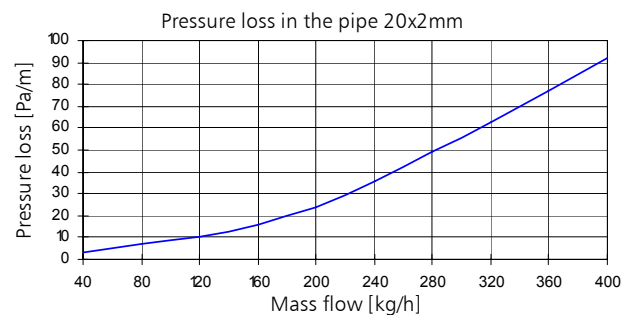

11. Layout for metal cassette ceiling heating with BEKA capillary tube mats

Project :	Date
Projekt consultant:	Layout valid for 22°C room temperature and 6K heating water spread !

Required Heating Capacity

1 Heat requirement for the room	W	from calculation of planning office
2 Planned coverage with mats	m ²	maximum possible arrangement derived from room dimensions
3 Required specific heating capacity	W/m ²	= heat requirement / coverage

Determination of Performance

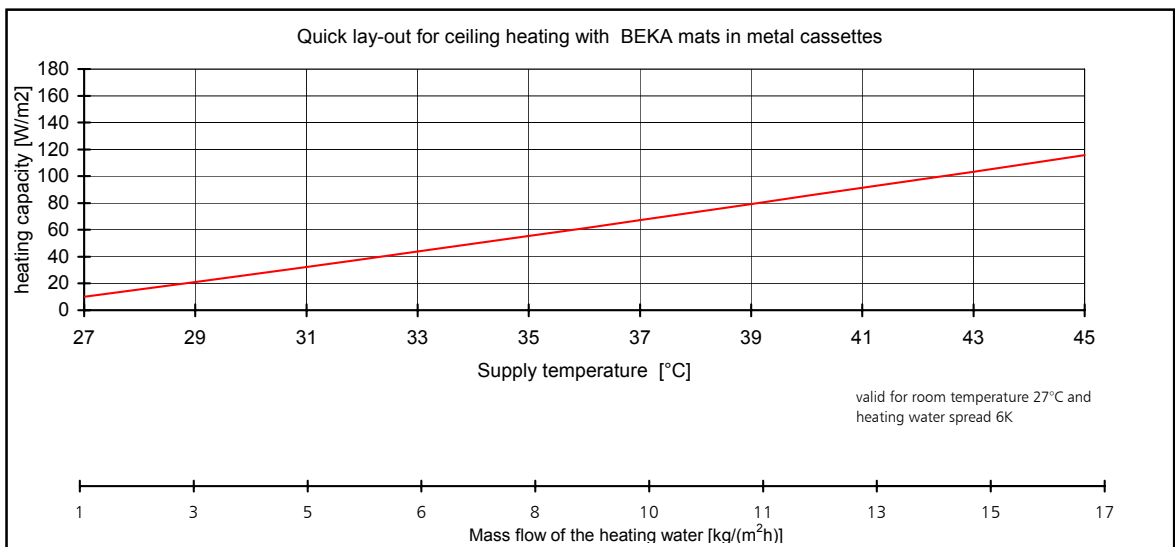

4 Supply temperature -> from diagram 1	°C	
5 Return temperature	°C	
6 Water volume per mat area	kg/(m ² h)	
7 Water volume per zone	l/h	

Pressure Loss Determination

8 Length of connection pipe	m	
9 Resistance in the pipe -> from diagram 2	Pa/m	
10 Pressure loss in the pipe = pipe length * resistance	Pa	
11 Pressure loss of the mat -> with value of line 2 from diagram 1	Pa	
12 Addition for pressure loss through fittings (recomm.: 30% addition to pipe)	Pa	
13 Addition for heat transfer station (recomm.: for zone valves 500 - 1000 Pa for mains regulating valves 700 - 1500 Pa for heat exchanger approx. 4000 Pa)	Pa	
14 Total pressure loss	Pa	

If BEKA heat transfer stations are utilised the determination of pressure losses can be omitted. Then only the quantity of heating circuits and the total heating capacity is required for the selection !

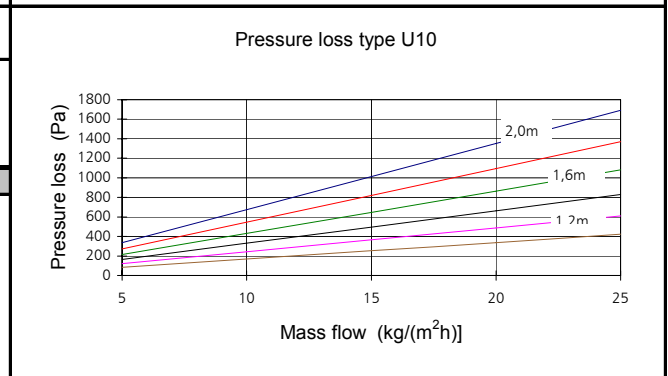
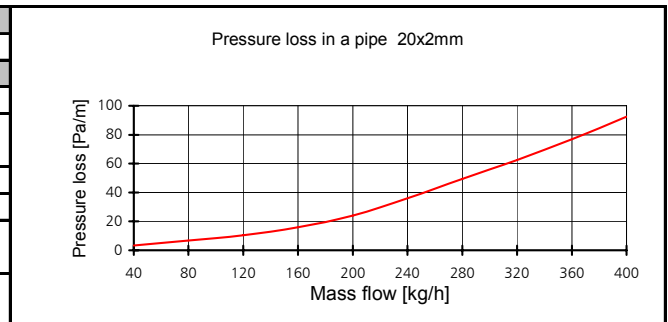

12. Technical specification

BEKA Capillary tube mats:

Type K.U10
Type K.UM10
Type K.G10

Material:

Polypropylene Random-Copolymer Type 3 DIN 8078

Geometry:

Collector pipe	20 x 2 mm
Capillary tube	3.35 x 0.5 mm
Capillary tube spacing	10 mm
Exchange surface	1.067 m ²

Size:

Length 600-6000 mm (in increments of 10 mm)
Width 150-1200 mm (in increments of 10 mm)

Masses:

0.43 kg/m² (empty, without collector)
0.82 kg/m² (filled, without collector)
Water content 0.39 l/m²

Cooling capacity:

Depending upon type
80 W/m² for metal cassette (DIN 4715)

Heating capacity

Depending upon type
up to 150 W/m²

Operating conditions:

Temperature-stable with permanent operation to 45°C
Operating pressure 3 to 4 bar
Test pressure 10 bar over 10 hours maximum

Application / mode of installation:

Cooling and heating ceilings for the installation on top of metal cassettes
Connections by quick-action coupling system

Delivery:

The mats are supplied lying flat in cartons or in one-way transport cassettes